



The City of Danbury, CT

Sealed Bid Request

BID TITLE: Bid #04-21-22-01 "Ornamental Street Lights & Bollards"

DATE BID OPENING: Tuesday, May 17, 2022

TIME: 10:00 AM

LOCATION: Purchasing Department, City Hall, 155 Deer Hill Avenue, Danbury, CT 06810

Bid Bond or Certified Check required with bid: Not Applicable

Performance Bond required if awarded bid: Not Applicable

The City of Danbury reserves the right to accept or reject any or all bids or any portion thereof, to waive technicalities, and to award the contract as deemed to best serve the public interest.

Omit State and Federal Taxes

All prices must be FOB Destination (Danbury, CT) unless otherwise specified

Dated in Danbury: April 13, 2022

Purchasing Agent \_\_\_\_\_

Charles J. Volpe, Jr.

Pursuant to and in accordance with the Invitation to Bid, Instructions to Bidders and catalog drawings, the undersigned agrees to furnish the items listed at the prices stated below:

Complete accompanying proposal page

Company: \_\_\_\_\_

Phone: \_\_\_\_\_

Address: \_\_\_\_\_

Fax: \_\_\_\_\_

\_\_\_\_\_

E-mail: \_\_\_\_\_

Submitted By (signature): \_\_\_\_\_

Payment Terms: \_\_\_\_\_

Signed By (print/type): \_\_\_\_\_

Title: \_\_\_\_\_

Dated: \_\_\_\_\_

Bid #04-21-22-01 "Ornamental Street Lights & Bollards"

PROPOSAL

Pursuant to and in accordance with the Invitation to Bid, General Information for Bidders and specifications relating thereto (see also following five pages for manufacturer's technical drawings), the undersigned offers to furnish the street lights and bollards listed at the prices stated below:

**Lights and Bollards to be purchased are replacements to match existing, and as such shall be manufactured by Main Street Lighting, Inc., Medina, OH. Substitutes are not acceptable.**

<u>Item</u>	<u>Quantity</u>	<u>Description</u>	<u>Unit Cost</u>	<u>Total Cost</u>
1.	+/- 6	Ornamental Street Lights with Photo Cells, and Electric Receptacles 10'-0" height, Windsor 17 Aluminum, Tapered Fluted Base Part No. AATF810/Blk Lum Part No. L100/120/Blk/ with Medium Base Bulb, LED-HID Equivalent Electrical Receptacle Part No. CO-20	\$ _____	\$ _____
2.	+/- 1	Ornamental Street Lights with Photo Cells, and Electric Receptacles 12'-0" height, Windsor 17 Aluminum, Tapered Fluted Base Part No. AATF812/Blk Lum Part No. L100/120/Blk/ with Medium Base Bulb, LED-HID Equivalent Electrical Receptacle Part No. CO-20	\$ _____	\$ _____
3.	+/- 5	Ornamental Bollards, MAL AL-1400 Black FC-JB	\$ _____	\$ _____
<b>TOTAL COST</b>				<b>\$ _____</b>

Street Lamps - Guaranteed delivery \_\_\_\_\_ weeks from receipt of order.

Bollards - Guaranteed delivery \_\_\_\_\_ weeks from receipt of order.

Prices shall remain firm for \_\_\_\_\_ days

All prices quoted shall be FOB Danbury, CT.

COMPANY \_\_\_\_\_

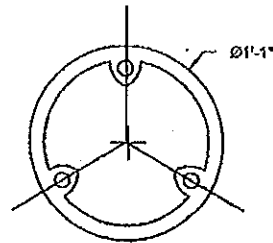

13" 3 HOLE ANCHOR BOLT CIRCLE STANDARD

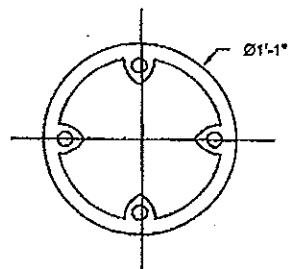

13" 4 HOLE ANCHOR BOLT CIRCLE STANDARD

**BOLT CIRCLE**  
**SCALE: 1" = 1'-0"**

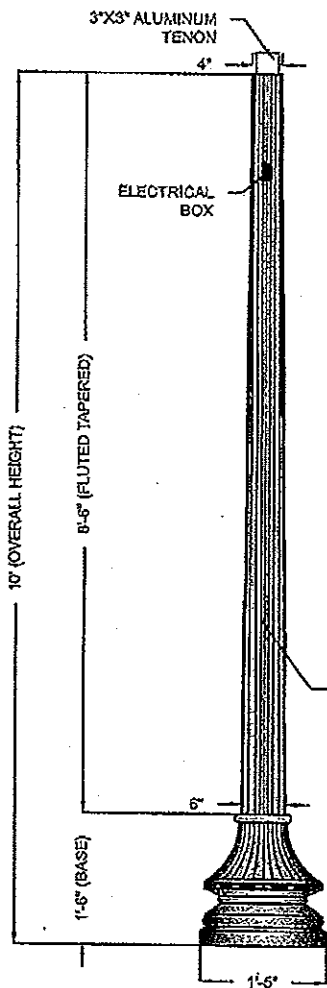

GLOSS BLACK POLYURETHANE PAINT STANDARD. OTHER COLORS & POWDERCOATING AVAILABLE.

**SIDE VIEW**  
**SCALE: 1/2" = 1'-0"**

**NOTES**

- 1. WIND SPEED 120 MPH
- 2. WIND LOADING 2.54
- 3. POLE WEIGHT 155 LBS.
- 4. WALL THICKNESS 0.125"

A	CREATED	JAH	05/18/17
B			
C			
REV:	DESCRIPTION:	BY:	DATE:

AMENDMENTS:			
SCALE AT A4.	DRAWN.	CHECKED.	REVISION.
1/2"=1'-0"	JAH	XXX	A
PART NO.	PROJECT NO.	DATE	
AATF-810	XX	05/18/17	

**TITLE: ALUMINUM-TAPERED-FLUTED**

**SITE: WINDSOR-17**



1080 INDUSTRIAL PKWY.  
 MEDINA, OH 44256  
 www.mainstreetlighting.com/

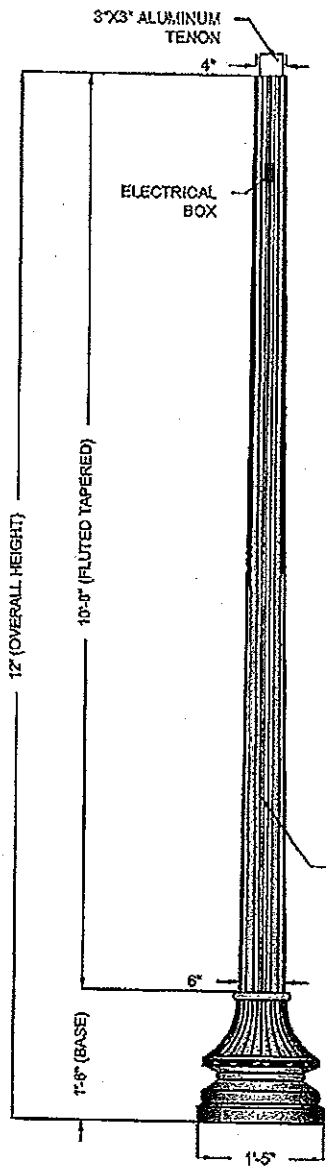

GLOSS BLACK POLYURETHANE PAINT STANDARD. OTHER COLORS & POWDERCOATING AVAILABLE.

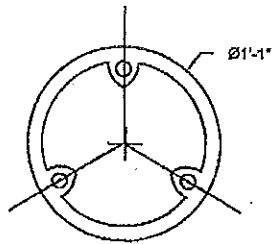

13" 3 HOLE ANCHOR BOLT CIRCLE STANDARD

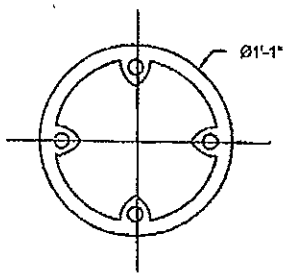

13" 4 HOLE ANCHOR BOLT CIRCLE STANDARD

BOLT CIRCLE SCALE: 1" = 1'-0" 2

SIDE VIEW SCALE: 1/2" = 1'-0" 1

**NOTES**

- 1. WIND SPEED 120 MPH
- 2. WIND LOADING 2.54
- 3. POLE WEIGHT 155 LBS.
- 4. WALL THICKNESS 0.125"

A	CREATED	JAH	05/18/17
B			
C			
REV:	DESCRIPTION:	BY:	DATE:

**AMENDMENTS:**

TITLE	ALUMINUM-TAPERED-FLUTED	SCALE AT A4	1/2"=1'-0"	DRAWN	JAH	CHECKED	XXX	REVISION	A
SITE	WINDSOR-17	PART NO.	AATF-812	PROJECT NO.	XX	DATE	05/18/17		



MAIN STREET LIGHTING

1080 INDUSTRIAL PKWY.  
 MEDINA, OH 44256  
 www.mainstreetlighting.com/

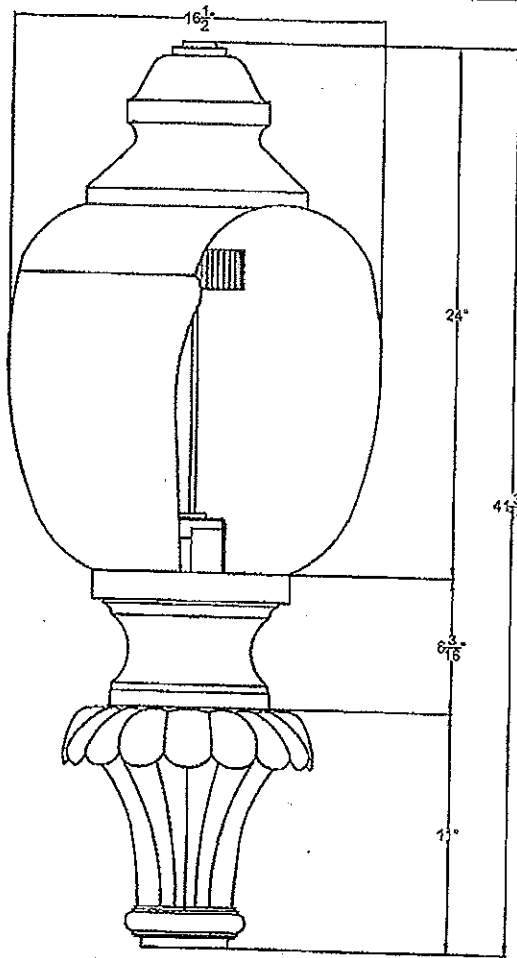

SIDE VIEW  
 SCALE: 1 1/2" = 1'-0" 1

**NOTES**

1. To Be Added.

A	CREATED	JAH	05/18/17
B			
C			
REV:	DESCRIPTION:	BY:	DATE:

**AMENDMENTS:**

TITLE:	L100	SCALE:	1.5"=1'-0"	DRAWN:	JAH	CHECKED:	XXX	REVISION:	A
SERIES:	L100-SERIES	PART NO.:	L100	PROJECT NO.:	XXX	DATE:	05/18/17		

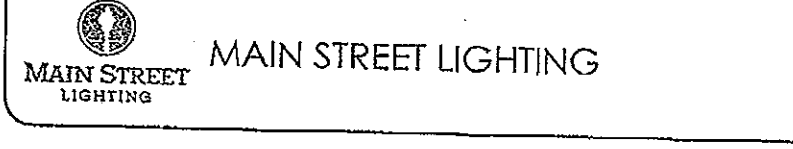

1080 INDUSTRIAL PKWY.  
 MEDINA, OH 44256  
[www.mainstreetlighting.com/](http://www.mainstreetlighting.com/)

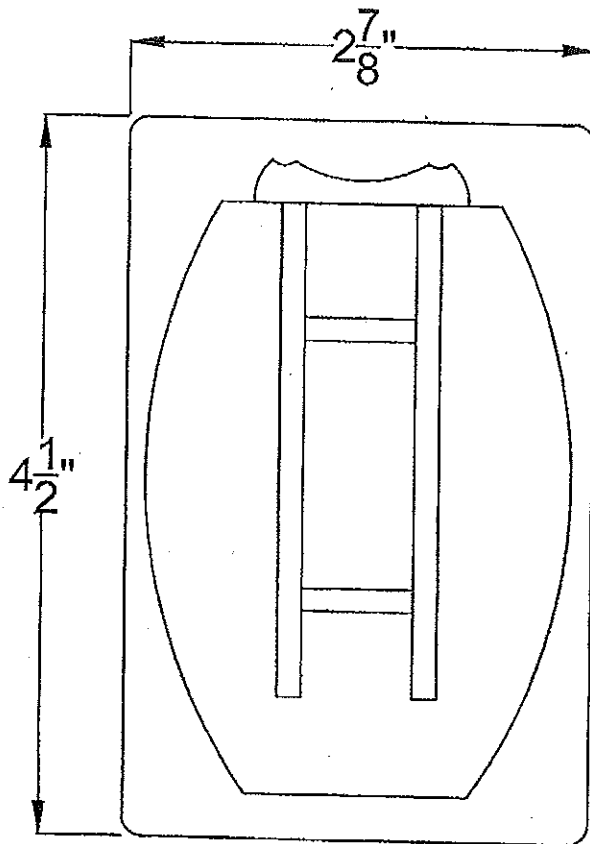

- NOTES:
1. INSTALLED (DUPLIX) 15 AMP
  2. STANDARD LOCATION 12" FROM TOP OF POLE
  3. GFI (GROUND FAULT) AVAILABLE UPON REQUEST.
  4. WWHU COVER (WET WHILE IN USE) - AVAILABLE UPON REQUEST (ADDITIONAL CHARGE).

SIDE VIEW  
SCALE: N.T.S

1

A	CREATED	JAH	05/18/17
B			
C			
REV:	DESCRIPTION:	BY:	DATE:

AMENDMENTS:

TITLE:	CO-20	SCALE AT A4:	N.T.S	DRAWN:	JAH	CHECKED:	XXX	REVISION:	A
STYLE:	ACCESSORIES	PART NO.:	CO-20	PROJECT NO.:	XX	DATE:	08/03/17		



MAIN STREET LIGHTING

1080 INDUSTRIAL PKWY.  
MEDINA, OH 44256  
[www.mainstreetlighting.com/](http://www.mainstreetlighting.com/)

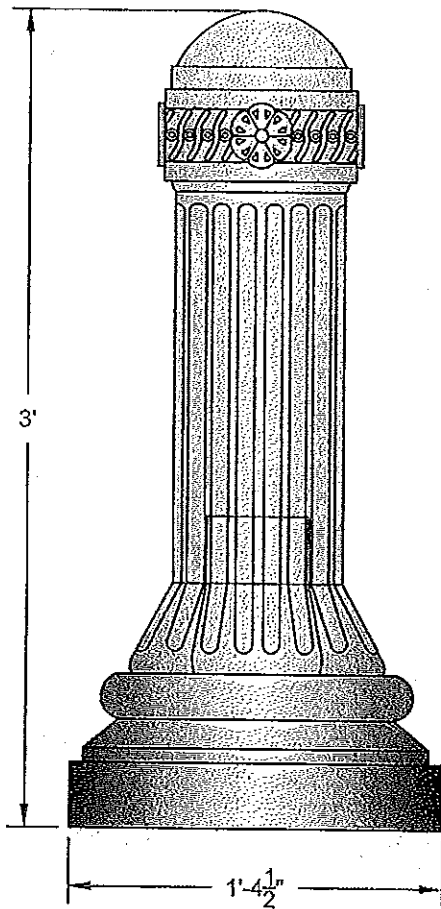

NOTES  
1. TBA

SIDE VIEW  
SCALE: 1 1/2" = 1'-0" 1

A	CREATED	JAH	05/18/17
B			
C			
REV:	DESCRIPTION:	BY:	DATE:

AMENDMENTS:

TITLE:	CAT-NO-AB1400	SCALE AT A4:	1.5"=1'-0"	DRAWN:	JAH	CHECKED:	XXX	REVISION:	A
STYLE:	HARRISBURG	PART NO.	AB1400	PROJECT NO.	XXX	DATE:	05/18/17		

**MAIN STREET LIGHTING**

1080 INDUSTRIAL PKWY.  
 MEDINA, OH 44256  
[www.mainstreetlighting.com/](http://www.mainstreetlighting.com/)

EXCEPTIONS

Page #	Paragraph	Item Description & Alternate Proposal



## REFERENCES

List Below at least five (5) references for similar projects, including all information requested. THIS PAGE MUST BE COMPLETED. If Bidders wish to keep their references confidential, this page may be removed from the bid package and submitted with the bid in a separate sealed envelope marked "REFERENCES – CONFIDENTIAL". The City of Danbury is not responsible for maintaining the confidentiality of the references unless this procedure is followed.

1) Client \_\_\_\_\_  
Project Address \_\_\_\_\_  
Approximate \$ Value \_\_\_\_\_ Date: Started \_\_\_\_\_ Completed \_\_\_\_\_  
Contact: Name \_\_\_\_\_ Telephone # \_\_\_\_\_

2) Client \_\_\_\_\_  
Project Address \_\_\_\_\_  
Approximate \$ Value \_\_\_\_\_ Date: Started \_\_\_\_\_ Completed \_\_\_\_\_  
Contact: Name \_\_\_\_\_ Telephone # \_\_\_\_\_

3) Client \_\_\_\_\_  
Project Address \_\_\_\_\_  
Approximate \$ Value \_\_\_\_\_ Date: Started \_\_\_\_\_ Completed \_\_\_\_\_  
Contact: Name \_\_\_\_\_ Telephone # \_\_\_\_\_

4) Client \_\_\_\_\_  
Project Address \_\_\_\_\_  
Approximate \$ Value \_\_\_\_\_ Date: Started \_\_\_\_\_ Completed \_\_\_\_\_  
Contact: Name \_\_\_\_\_ Telephone # \_\_\_\_\_

5) Client \_\_\_\_\_  
Project Address \_\_\_\_\_  
Approximate \$ Value \_\_\_\_\_ Date: Started \_\_\_\_\_ Completed \_\_\_\_\_  
Contact: Name \_\_\_\_\_ Telephone # \_\_\_\_\_

\_\_\_\_\_  
Company  
\_\_\_\_\_  
Street  
\_\_\_\_\_  
City, State, Zip

Bid Title \_\_\_\_\_  
Bid # \_\_\_\_\_  
\_\_\_\_\_  
Telephone #

## INSTRUCTIONS TO BIDDERS

Sealed bids will be received at the Office of the Purchasing Agent, 155 Deer Hill Avenue, Danbury, CT 06810 until the time and date specified on the cover sheet. Bids received later than the time specified will not be accepted. In the event of the closure of City Hall, bids will be opened on the following day that City Hall is opened. Amendments to or withdrawal of any section of the submitted bid received later than the time & date set for the bid opening will not be considered. Bid proposals must remain in effect for a minimum of 30 days unless otherwise noted elsewhere in the bid specifications.

**BID DOCUMENTS:** are available upon receipt of this invitation (if not attached) over the internet at the City's website: [www.danbury-ct.gov](http://www.danbury-ct.gov). Adobe Acrobat reader is required to view this document. If you do not have this software you may download at no cost from Adobe at <http://www.adobe.com>. Businesses without internet access may obtain a copy of the bid by contacting the Purchasing Agent's Office, City Hall, 155 Deer Hill Avenue, Danbury, CT 06810, (203) 797-4571.

**BID BONDS:** if applicable, shall be in the amount of 5% of the total bid made out in favor of the City of Danbury and issued by a Surety company acceptable to the City of Danbury, and must accompany each bid. A certified check in the same amount may be submitted in lieu of the bid bond. Bids submitted without Certified Check or Bid Bond will not be accepted. The City of Danbury will not be held liable for the accrual of interest on any check held by the City in conjunction with this bid. All checks or bid bonds will be refunded to the unsuccessful bidders after award of the bid. The deposit check or Bid Bond of the successful bidder will be held in escrow until such time as the City determines that the bidder has or will meet their obligations as stated by the bid. If the bidder fails or refuses within a reasonable time after due notice that the contract has been awarded, to execute the same, an amount representing a loss to the City by reason of such failure shall be retained and paid into the City treasury.

**REPLIES:** whether bid or no bid, must have the bid number clearly identified on the outside of the envelope. Bidders not marking the envelopes with the Bid number and date/time of opening on the envelope will have no recourse against the City of Danbury or its employees. Such bidders run the risk of the bid being opened prior to the scheduled Bid Opening time. Once opened such bids are public record. Any alleged oral agreement made by a bidder or contractor with any agency or employee of the City of Danbury will be disregarded.

**FREIGHT:** Prices quoted shall be net delivery **F.O.B. Danbury, CT**. All bid prices must include prepaid delivery, assembly, and/or installation (ready for operation and/or use) of all equipment and/or materials to the individual locations(s) as designated by the Purchasing Agent. All bid prices are to be submitted on the sheets provided for this bid. Quantities and pricing are to be listed in accordance with these sheets.

**QUESTIONS:** Request for interpretation of any portion of the bid may be made by telephone to the Purchasing Agent at 203-797-4571. All replies will be given verbally and a copy of any such inquiry and advice (if deemed vital to the bid by the Purchasing Agent) will be made available to each prospective bidder in the form of an addendum. Bidder should check the City's website for addendums/updates 48 hours prior to the bid opening.

**IDENTICAL BIDS:** In the event of receipt of identical bids as to offerings, delivery, service, content, price, etc., the bid will be awarded in accordance with the information contained in the bid document, based on first received as to date and time of receipt of the bid.

**NON-COLLUSION STATEMENTS:** In order for bids to be considered, a non-collusive statement must be submitted with the bid. A sample non-collusive bid statement is attached. Bidders may elect to submit their own notarized non-collusion statement.

**CONDITIONAL, QUALIFIED OR NON-RESPONSIVE BIDS/PROPOSALS:** All bids/proposals shall be submitted in the form and manner as indicated by the bid documents and bid forms. Any proposal which is not submitted in the form and manner indicated by the bid documents or which contains information, statements, conditions, or qualifications which place conditions or qualifications on the proposal submittal for purposes of making an award, or which alter any proposal terms, conditions, specifications, or forms, which has not been previously approved by written addendum from the Purchasing Agent, or which does not meet legal requirements, shall be declared as a qualified, conditional, or non-responsive proposal and shall be rejected without further consideration. Any proposal response that does not fully respond to and comply with all detailed specifications or requests for information, including execution of proposal forms, may be declared "non-responsive" and recommended for rejection. The City of Danbury shall not be responsible for any errors or omissions by the Offeror.

**UNBALANCED BIDS AND/OR EXCESSIVE LINE ITEM PRICES:** The City reserves the right to reject any bids in which unit prices, in the sole opinion of the City, are unbalanced. In addition, where the City has decided to make an award, it further reserves the right to non-utilize a particular line item that in the sole opinion of the City is excessively priced, and reserves the right to obtain that item from another source

**CONTRACT:** A response to an Invitation to Bid (ITB) is an offer to contract with the City of Danbury based upon the terms, conditions and specifications contained in the City's ITB. Bids do not become contract unless and until executed by the City.

**TAXES:** Omit all State and Federal taxes from the bid. The City of Danbury is exempt from the payment of taxes imposed by Federal government and/or the State of Connecticut.

**OWNERSHIP OF DOCUMENTS:** All documents, including drawings, plans, specifications, videotapes, or other documents or maps prepared by a contractor pursuant to any agreement arising from this bid shall become the property of the City of Danbury upon completion of the project or any termination of the project prior to the completion of the project.

**LEGALITY:** All bid offers for commodities, work, materials, or equipment hereunder shall comply in every respect with the laws, specifications and requirements of the State of Connecticut and the Federal government. Contractor will comply with the provisions of the Connecticut Fair Employment Practices Law.

**LANGUAGE DISPUTES:** Any disputes over the interpretation and/or meaning of any individual terms, conditions, and/or language within this Request for Bid/Proposal document shall be resolved by and at the sole discretion of the City Purchasing Agent in a manner that is in the best interest of, and best advantage to, the City of Danbury, provided any such interpretation shall be reasonable.

**RESPONSIBILITY:** The Contractor shall save the City of Danbury, its agents or employees, harmless from liability of any kind for all claims of labor payments and materials furnished for this work, and for use of any copyrighted or uncopyrighted composition, secret process patented or unpatented invention, article or application furnished or used in the performance of the contract of which the Contractor is not the patentee, assignee, or licensee. The successful bidder agrees to indemnify and hold harmless the City of Danbury, its agents and employees from any and all liability arising out of the successful bidders' operations, functions and/or supplied items.

The successful bidder, vendor, and/or contractor must protect all property of the City of Danbury (i.e. all floors, furniture, grass, land, etc.) from injury or other damage. Any damage so caused must be repaired by contractor/vendor at his/her own expense. At the completion of work, the vendor and/or contractor must remove from the premises all surplus materials and all debris created by same. The premises must be left in a broom-clean and finished condition acceptable to the owner or its agents. Successful bidder will furnish adequate protection from damage for all work and to repair damage of any kind, for which he or his workers are responsible, to the premises or equipment to his own work or to the work of other contractors.

**DEFAULT:** It shall be understood that a bidder supplying equipment and/or supplies will be considered to be in default if/when they have not delivered the item(s) within the time constraints listed in this document or subsequent purchase orders and/or contract. Bidders providing a service and/or construction will be considered to be in default if/when they have failed to meet the completion date set forth in this document or its subsequent contract and/ or purchase orders and/ or they have ceased work on the project for a period of fifteen (15) working days, cumulative or consecutive.

**TRADE NAME REFERENCES:** Any and all references to trade names, types, styles, model numbers, stock numbers or catalogs are intended to be descriptive only and not restrictive. The intention is to indicate to bidders the type and quality of the articles and or materials that will be satisfactory. When reviewing the information, it is the responsibility of the prospective bidder to inform the City of Danbury of any discrepancy that is found (i.e. number listed does not fit item description). Bids received on other makes or models with reference to other catalogs will be considered. The bidder is to clearly state in his/her bid exactly what he/she intends to furnish and to furnish with his/her bid a cut or illustration or other descriptive matter that will clearly indicate and give specification as to the product he/she proposes to furnish. Where a bid is offered on an item other than the trade standard used in the specification the item should be identified on the bid form by entering the MAKE, TRADE NAME AND MODEL NUMBER. It is understood that any substitute and/or alternate that might be offered are guaranteed by the bidder to be of equal or better quality than is referenced in the bid. The item(s) must be equivalent as to function, basic design, type and quality of material, method of construction and any required dimensions. It shall be further understood that during original as well as subsequent shipments spot checks will be performed to insure that the items received are in fact the items offered in the bid. When received, should items/materials prove to be different from what was bid in any way, the bidder agrees to the return of the items and agrees to supply

correct items (per bid specifications) at the bidders expense. In the event this return action is required, it is understood the bidder may be subject to removal from the City's approved bidder's list. Bidders are cautioned that surplus, seconds, factory rejects, floor samples, close outs or distressed items are not acceptable and shipments of substitutions, defective or shop-worn equipment will be returned for a full refund at the vendor's expense.

**QUANTITY:** The quantities and/or materials listed in the specifications/bid sheets may be increased or decreased by the City of Danbury or its designated representative based on actual need at the time the purchase orders are placed.

**QUALITY:** The City of Danbury reserves the right to reject any proposal in whole or in part offering equipment and/or materials and/or services that in its or its agent's opinion does not meet the quality standards desired. Such decision is final and not subject to further recourse by the bidder.

**SAMPLES:** forwarded by the bidder will be returned to the bidder at his request and expense. Requests for return of samples must be submitted in writing at the time the sample is given to the City of Danbury or its representative. Samples not returned to the bidder will be disposed of at the discretion of the City of Danbury or its designated representative. Large pieces of equipment submitted for evaluation and inspection are to be picked up by the bidder within 30 days of the bid opening date. The City of Danbury or its designated agent will dispose of items not picked up within 30 days.

**AWARD:** It is the intent to award this bid in its entirety to one bidder, however, the City reserves the right to award the bid line item by line item if it is deemed in its best interest to do so. In addition, bidders are advised that should budgetary constraints dictate, part, and/or all the items in this bid may be rejected. This decision shall be considered final and not subject to recourse by the bidder.

In determining the lowest or highest responsible bidder, the City reserves the right to consider, in addition to price, the compatibility, quality, cost of maintenance and availability of parts, experience and/or past performance of the bidder, sufficiency of the financial resources of the bidder as relates to the offerings as well as the ability of the bidder to provide future maintenance and service.

Documents previously submitted to the City of Danbury will not be considered as satisfying submission requirements for this bid.

No bidder can claim any contract rights by virtue of bidding alone. Awarding of the contract means actual written notice by letter and a properly executed purchase order to the bidder or bidders to whom the bid has been awarded.

**OPTION TO RENEW:** This bid, once awarded, may be extended by mutual consent for up to two (2) additional one-year periods.

**BONDS** (if applicable):

**Performance Bond:** The Contractor, when awarded the Bid, must submit within 10 days of the bid award, and before beginning the work or signing a contract, a Performance Bond amounting to one hundred percent (100%) of the total amount of the bid. Said performance bond must be in favor of the City of Danbury and executed by a surety company authorized to do business in the State of Connecticut. The City of Danbury reserves the right to retain the Bid Bond or Certified Check on bids below \$25,000.00 as a Performance Bond. On bids of \$25,000.00 or more the Performance Bond may be furnished in the following manner: Performance Bond, Surety Bond, Certified Check, Bank Check, Savings Account in both the City & Vendor's name or Letter of Credit.

**Maintenance Bond:** The contractor, upon signing a contract and before beginning the work, must submit to the Purchasing Agent a Maintenance Bond to guarantee that if defects in either labor or materials become evident within one year after completion and acceptance of work will be fixed at no cost to the City of Danbury. The maintenance bond may be included as a portion of the Performance Bond or as a separate bond. If it is issued as a separate bond said maintenance bond must be in favor of the City of Danbury and issued by a surety company licensed and authorized to do business in the State of Connecticut.

**Labor and Material Bonds:** Pursuant to Section 49-41(a) of the Connecticut General Statutes, as may be amended from time to time, a project for the construction, alteration or repair of any public building or public work, where the contract award amount is in excess of \$100,000.00, a labor (payment) and material bond in the full amount of the contract must be furnished to the City with a surety or sureties satisfactory to the City. Said bonds

shall be filed with the Purchasing Agent on or before the award date. Any such bond shall have as principal the name of the person awarded the contract.

**Consent for Release of Final Payment:** AIA Document G707 & G706, or equivalent, must be signed and returned by the Surety Company before final payment will be released to the contractor.

## **INSURANCE:**

**Certificate of Insurance:** All insurers must have an AM Best rating of A-V11 or better and admitted to do business in the State of Connecticut. All insurance policies must include a Waiver of Subrogation whereby the insured waives its right to subrogate against the City, its subsidiaries, employees, volunteers, directors and officers. Proof of proper insurance coverage, Workers Compensation Insurance, Liability and Property damage, and Vehicle Insurance shall be filed with the City of Danbury Purchasing Agent within 10 days after the award of the bid. The Certificate of Insurance must name the City of Danbury, 155 Deer Hill Avenue, Danbury, CT 06810, its subsidiaries, employees, volunteers, directors & officers as the "additional insured" and filed with the Purchasing Agent prior to commencement of work. Renewal Certificates of Insurance must be mailed to the Purchasing Agent 10 days prior to the expiration of the required coverage.

**Workman's Compensation Insurance:** The Contractor shall take out and maintain during the life of the contract adequate Workman's compensation Insurance for all the employees employed on said work. In case any class of employees or subcontractors is engaged in hazardous work under the contract at the site of the work is not protected under the Workman's Compensation statute, the contractor shall provide Workman's Compensation Insurance for the protection of employees not otherwise protected.

**Liability Insurance:** The Contractor shall take out and maintain for the life of the contract, adequate public liability insurance insuring against liability to persons not employed by him in an amount of not less than \$1,000,000.00 for injuries, wrongful death to any one person and subject to the limit for each person in an amount of not less than \$2,000,000.00 on account of one accident and property damage insurance in an amount of not less than \$1,000,000.00.

**Vehicle Insurance:** The Contractor shall take out and maintain for the life of the contract, adequate automotive/truck or other vehicle insurance with minimum coverage of \$1,000,000.00 each for both liability and under insured and uninsured motorist as well as any other coverage required by the State of Connecticut or requested by an official of the City of Danbury as relates to the contract.

**Additional Security:** The City of Danbury reserves the right to require successful bidders to enter into and such security arrangements as are deemed necessary to protect the City of Danbury, its property and goods.

**PERMITS:** The successful bidder agrees to obtain all work/building permits as might be required. The cost of obtaining such permits is the responsibility of the bidder. The City of Danbury reserves the right to waive local permit fees. In addition, it shall be understood that where property lines are to be considered, bidders are to verify said lines and measurements with proper City Officials prior to commencement of work. It is to be understood that any/all specifications and/or plans or drawings contained in or developed as a result of the bid process are and shall be presented subject to the approval of the City of Danbury planning, zoning and building officials and that awards made prior to said approval are subject to cancellation.

**PREVAILING WAGE:** When the State of Connecticut Prevailing Wage Rate is applicable to the bid, the successful bidder must submit a Certified Payroll Record prior to any request and/or invoice for payment.

## **SAFETY:**

**Machine and/or Equipment Hazard Assessment and Safety Training:** Upon delivery of machines and/or equipment, suppliers are required to provide to the end-user employees, at no additional charge, a training session, which will emphasize hazard awareness and assessment and the safe use of such machinery/equipment.

**Occupational Safety and Health Act of 1970:** Seller shall warrant that the machinery, equipment or other

materials covered hereby shall upon delivery to the City of Danbury, be in compliance with the standards required by said Act and any updates as pertain to or reference said Act as well as the standards required by comparable State and local laws, if any, for such machinery, equipment or other materials in effect at the time of delivery.

**Machines and/or Equipment Lockout/Tag out:** In an effort to comply with OSHA's final rule on the control of hazardous energy sources, vendors must warrant that any and all machines and/or equipment as is covered under this bid will be supplied and/or installed equipped with lockout/tag out devices as prescribed by OSHA.

**Toxic Substance Control Act (PL94-469):** Seller warrants that each and every chemical substance constituting or contained in the products sold or otherwise transferred to the City of Danbury under this bid and subsequent purchase orders is not on the list of prohibited chemical substances compiled and published by the Administrator of the Environmental Protection Agency pursuant to Act PL94-469 and are otherwise in compliance with said Act.

**Hazardous Materials:** Any materials required by this bid and subsequent purchase orders that are hazardous under federal, state, or local statute, ordinance, regulation, or agency order will be packaged, labeled, marked and shipped by the seller to comply with all federal, state and local regulations then in effect including but limited to the provisions of the Hazardous Materials Transportation Act and Regulations promulgated there under and will further comply with any special requirements and any policies and procedures of the City of Danbury relating to the purchase of hazardous materials as might be noted on subsequent purchase orders or otherwise communicated to seller in writing.

**Material Safety Data Sheets:** Shall be provided by the Seller upon delivery to the City of Danbury of any goods having constituents listed in the following references - OSHA 1910, ACHIG Current Threshold Values, DOT HazMat Table 49, IARC Carcinogen List, National Toxicology Program Carcinogen List, and/or Radioactive Materials. These Material Safety Data Sheets must be consistent with and include information required by the OSHA Hazard Communication Standard published as 29 CFR 1910.1200, as the same may be amended or supplemented from time to time.

**Asbestos:** Bidders are advised that asbestos-containing material may be located in the boiler rooms, pipe tunnels, storage areas and various portions of City buildings. Before proceeding on any contractual work on City buildings or their interiors, it is mandatory that bidders familiarize themselves with the asbestos-containing material and that said material be considered as a health hazard and all precautionary measures according to the Ahera Rules & Regulations be observed. It is the bidder's responsibility to notify all employees and/or subcontractors of this notification.

**SUBCONTRACTORS:** The successful bidder shall not employ any subcontractor to fulfill any of the duties herein specified without express, prior written approval of the City of Danbury or its designated agent.

**EEO:** The successful bidder shall provide any/all additionally required, affirmative action statements, fair employment plans and non-discrimination programs and statement as might be required by the City of Danbury. In connection with the execution of this bid, subsequent purchase orders and/or contracts, the seller shall not discriminate against any employee or applicant for employment because of age, race, religion, color, sex or national origin. Bidders must comply with all rules & regulations of the Department of Labor with regard to Equal Employment Opportunities as pertains to municipalities.

**TERMINATION OF CONTRACT:** Any contract entered into by the City and the successful bidder shall provide that the City may terminate the contract upon thirty (30) days notice to the bidder.

**The City of Danbury reserves the right to award or reject any or all bids, or any portion thereof, to waive technicalities, and to award the bid and/or contracts to one or more bidders submitting essentially identical proposals and, that in the City's judgment, will best serve the public interest.**

The terms and conditions of these "Instructions to Bidders" are made a part this bid.

**SAMPLE FORM**

Bid # \_\_\_\_\_

**NON-COLLUSION AFFIDAVIT**

STATE OF \_\_\_\_\_ COUNTY OF \_\_\_\_\_

I, \_\_\_\_\_ being first duly sworn, deposes and says that:

1. I am \_\_\_\_\_ of \_\_\_\_\_, the bidder that has submitted the attached request for bid for \_\_\_\_\_;
2. I am fully informed respecting the preparation and contents of the attached bid and of all pertinent circumstances respecting such bid;
3. Such bid is genuine and is not a collusive or sham bid;
4. Neither the bidder nor any of its officers, partners, owners, agents, representatives, employees or parties of interest, including this affiant, has in any way colluded, conspired, connived or agreed directly or indirectly with any other bidder, firm or person to submit a collusive or sham bid in connection with the work for which the attached bid has been submitted nor has it in any manner, directly or indirectly, sought by agreement or collusion or communication or conference with any other bidder, firm or person to fix the price or prices in the attached bid or of any other bidder, or to fix any overhead, profit or cost element of the bid price or the price of any bidder, or to secure through any collusion, conspiracy, connivance or unlawful agreement any advantage against the City of Danbury or any person interested in the proposed bid; and
5. The price or prices quoted in the attached bid are fair and proper and are not tainted by any collusion, conspiracy, connivance or unlawful agreement on the part of the bidder or any of its agents, representatives, owners, employees, or parties in interest, including this affiant.

Signed \_\_\_\_\_

Title \_\_\_\_\_

Subscribed and sworn to before this

\_\_\_\_\_ day of \_\_\_\_\_, 20\_\_\_\_\_.

\_\_\_\_\_

\_\_\_\_\_

My commission expires \_\_\_\_\_

**SAMPLE FORM**

Bid # \_\_\_\_\_

**CONSENT OF SURETY COMPANY TO RELEASE FINAL PAYMENT**

- City
- Architect
- Contractor
- Surety
- Other

PROJECT/BID NUMBER:

TO: City of Danbury  
 Attn: Purchasing Agent  
 155 Deer Hill Avenue  
 Danbury, CT 06810

CONTRACTOR: \_\_\_\_\_  
 \_\_\_\_\_  
 \_\_\_\_\_  
 \_\_\_\_\_

In accordance with the provisions of the contract between the City of Danbury and the contractor as indicated above, the (insert name & address of Surety Co.)

\_\_\_\_\_, SURETY COMPANY on bond of  
 (insert name & address of Contractor) \_\_\_\_\_

\_\_\_\_\_, CONTRACTOR, hereby approves of the final payment to the Contractor, and agrees that final payment to the Contractor shall not relieve the surety Company of any of its obligations to the City of Danbury as set forth in the Surety Company's bond.

Subscribed and sworn to before this  
 \_\_\_\_\_ day of \_\_\_\_\_, 20\_\_\_\_

\_\_\_\_\_  
 \_\_\_\_\_  
 Notary Public

\_\_\_\_\_  
 Surety Company

\_\_\_\_\_  
 Authorized Representative's Signature

\_\_\_\_\_  
 Title

My commission expires \_\_\_\_\_



## BID SUBMITTAL CHECKLIST

THE FOLLOWING ITEMS ARE TO BE INCLUDED WITH YOUR BID SUBMITTAL:

- BID COVER SHEET – WITH YOUR COMPANY INFORMATION COMPLETED
- PROPOSAL SHEET(S), IF SEPARATE FROM THE BID COVER SHEET
- EXCEPTIONS PAGE
- REFERENCES PAGE
- NON-COLLUSION AFFADAVIT

**PLEASE NOTE REPLIES:** whether bid or no bid, must have the bid number clearly identified on the outside of the envelope. Bidders not marking the envelopes with the Bid number and date/time of opening on the envelope will have no recourse against the City of Danbury or its employees. Such bidders run the risk of the bid being opened prior to the scheduled Bid Opening time. Once opened such bids are public record. Any alleged oral agreement made by a bidder or contractor with any agency or employee of the City of Danbury will be disregarded.